

THE

730th

ORD. (L.M.) CO.

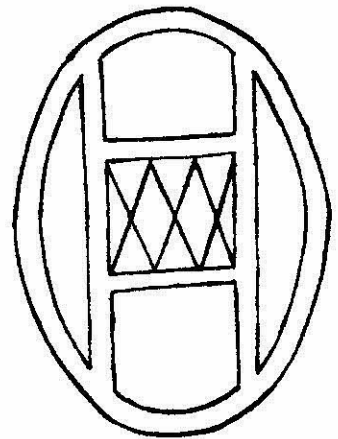
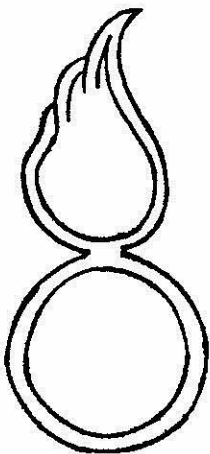

N O T E

THE STAFF OF OFFICERS AND ENLISTED MEN WHO COMPILED
THE UNIT HISTORY OF THE 730TH ORDNANCE (LM) COMPANY
INCLUDES THE FOLLOWING:

| | | |
|---------------------|---------|--------------------|
| JULIUS F. MERKEL, | 1st Lt. | UNIT HISTORIAN |
| Donald M. Mathias, | Cpl. | EDITOR |
| Anthony J. Klayner, | Tec 5. | CHIEF PHOTOGRAPHER |
| Edward G. Heidrich, | Tec 4. | PHOTOGRAPHY |
| Glenn L. Kilborn, | T/Sgt. | PHOTOGRAPHY |
| Stuart M. Hall, | T/Sgt. | DESIGN & DRAWINGS |

DIVISION ORDNANCE OFFICER

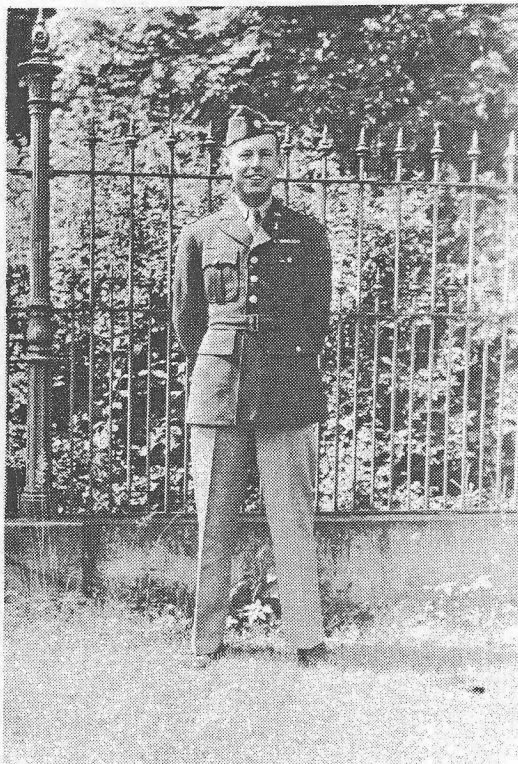

WARD R. TREVERTON LT. COL.
COLORADO DENVER
1320 HUDSON STREET
BRONZE STAR 3 FEBRUARY 1941

ASST. ORDNANCE OFFICER

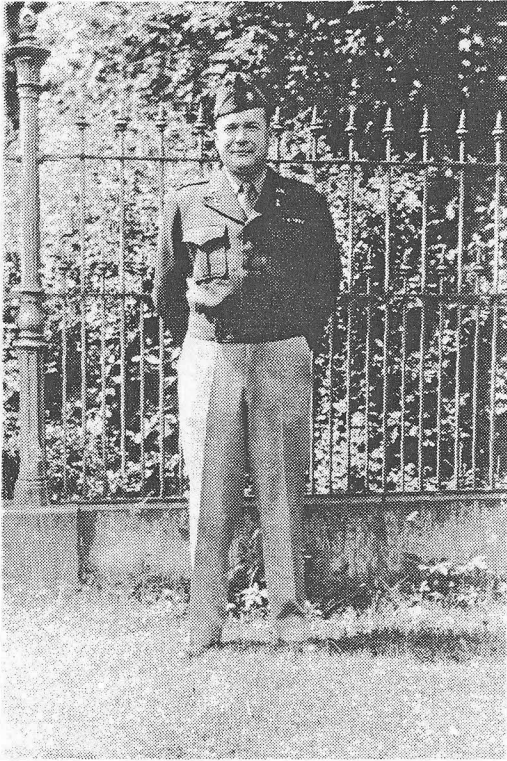

**TRUMAN O. EWING MAJOR
INDIANA INDIANAPOLIS
3917 N. CAPITOL AVENUE
BRONZE STAR 25 JUNE 1942**

COMMANDING OFFICER



ALLEN L. AMEND CAPTAIN
ARIZONA GLENDALE
41 WEST "C" AVENUE
BRONZE STAR 18 FEBRUARY
1941

DIVISION AMMUNITION OFFICER

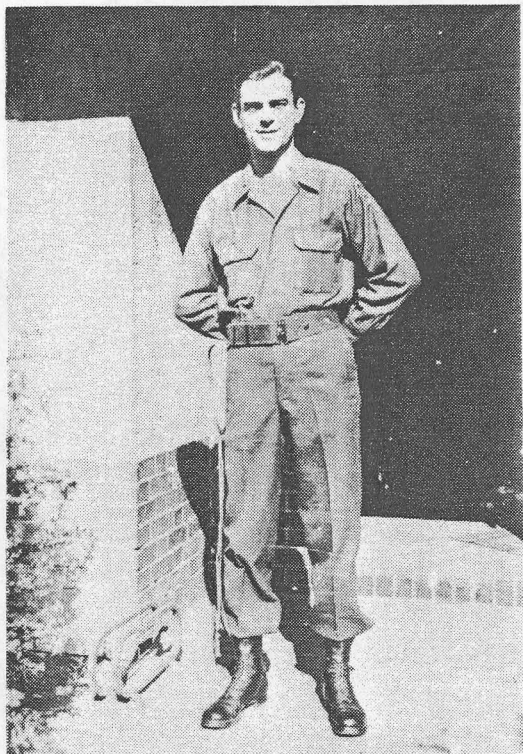

WILLIAM J. WILSON CAPTAIN
PENNSYLVANIA McKEESPORT
3015 STATE STREET
BRONZE STAR 14 MAY 1941



CHAPLAIN

SAMUEL J. HIEBERT CAPT.

CHAPLAINS CORPS

HQ. SPECIAL TROOPS

30TH INFANTRY DIVISION

WASHINGTON BLAINE

3 JUNE 1945



FIRST SOLDIER



WILLIAM H. YOUNG 1ST/SGT
INDIANA MARION
505 W. 4TH STREET
BRONZE STAR 13 NOVEMBER 1941

SECTION LEADERS

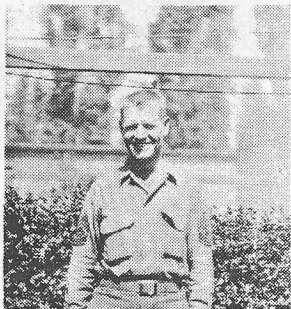

WARREN P. SULLIVAN Jr. M/SGT
DIVISION ORDNANCE OFFICE
SOUTH CAROLINA COLUMBIA
1000 BULL STREET APT. #2
BRONZE STAR 16 SEPTEMBER 1940

T/SGT GLENN L. KILBORN
PETOSKEY MICHIGAN
DIVISION AMMUNITION OFFICE
BRONZE STAR
8 AUGUST 1941

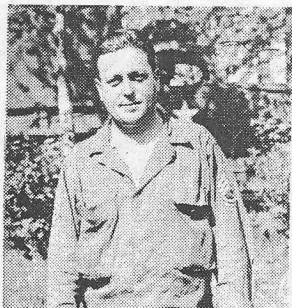

FRANKLIN BOAZ T/SGT
TENNESSEE NASHVILLE
AUTOMOTIVE SECTION
501 MEMORIAL APARTMENTS
BRONZE STAR 16 SEPTEMBER 1940

T/SGT ROY C. WALKER
TELLICO PLAINS TENNESSEE
ARMAMENT SECTION
CERTIFICATE OF MERIT
15 MARCH 1941



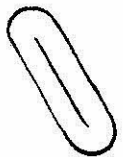
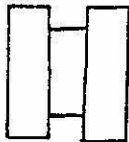
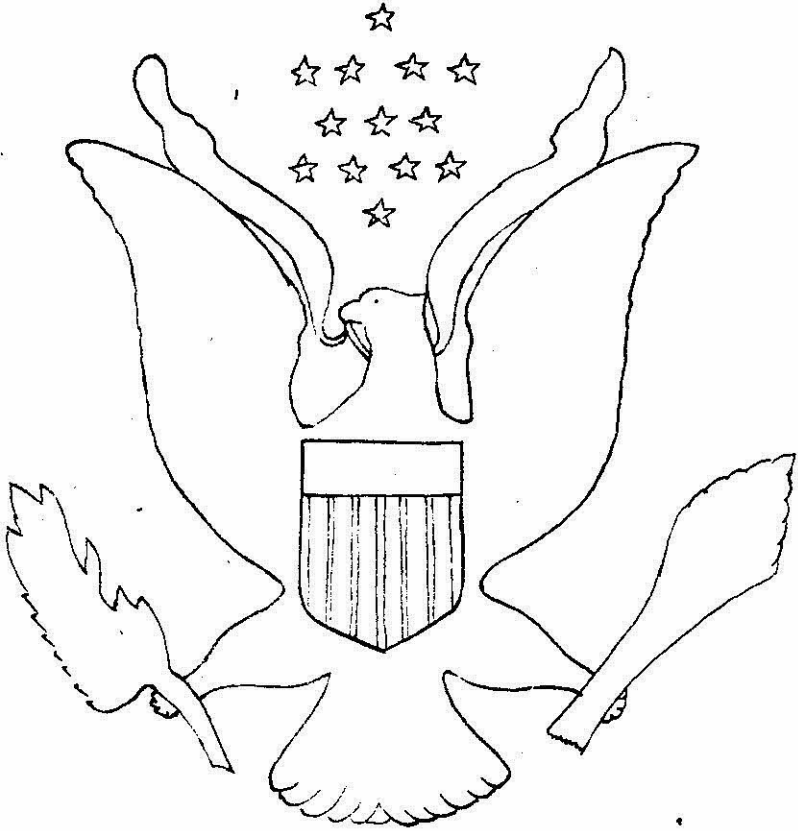



FIRST ROW, L - R
TREVERTON, LT. COL., EWING, MAJ.,
WILSON, CAPTAIN., AMEND, CAPTAIN.
BACK ROW, L - R
ADAMS, 1ST LT., ABLE, CAPTAIN.,
AMOS, 1ST LT., MIDDLETON, 1ST LT.,

OFFICERS OF 730TH ORDNANCE (LM) COMPANY

D.O.O.

18

DAO

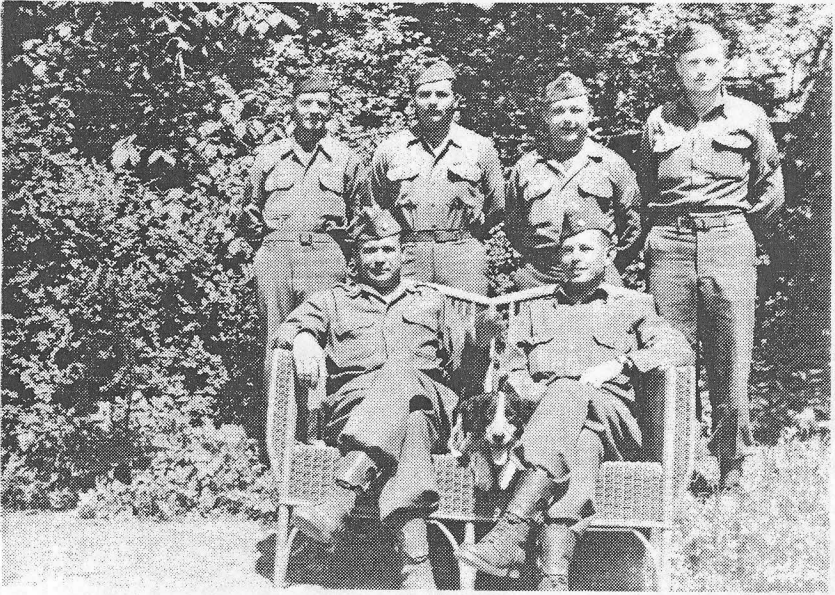

DIVISION ORDNANCE OFFICE



DIVISION AMMUNITION OFFICE



GLENN L. KILBORN T/SGT
MICHIGAN, PETOSKY, RFD #2
12 SEPTEMBER 1941
BRONZE STAR

TEC 3 PAUL L. GAUMER
LOGANSPORT, INDIANA
717 RACE ST.
10 APRIL 1941

CERTIFICATE OF MERIT



GEORGE S. BOCSKOR TEC 4
OHIO, AKRON
1013 CELINA AVE
10 NOVEMBER 1942 CERTIFICATE OF MERIT

TEC 5 ALLEN E. LOOMIS
ELKTON, MARYLAND
504 BOW ST
7 NOVEMBER 1942

CERTIFICATE OF MERIT



GORDON E. PAITRICK TEC 5
WISCONSIN BEAVER DAM
131 CLEVELAND ST
31 DECEMBER 1943

PFC HENRY B MOORE Jr.
BRISTOL, VIRGINIA
408 PARK ST
29 SEPTEMBER 1942

CERTIFICATE OF MERIT





DUANE RUSE PFC
CALIFORNIA HERMOSA BEACH
925 - 15TH PLACE
28 SEPTEMBER 1942

TEC 5 HOMER L. STIME
SANTA PAULA, CALIFORNIA
127 NORTH 8TH ST
14 SEPTEMBER 1942



E. C. FANN Jr. PFC
ALABAMA HUNTSVILLE
801 8TH AVE
8 OCTOBER 1942 CERTIFICATE OF MERIT

HEADQUARTERS

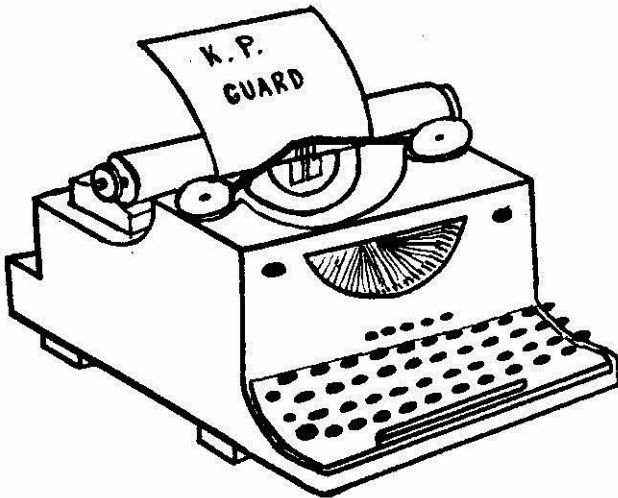



FRONT ROW L - R

MOODY, PERRY, BEAL, ROBINSON, PEDDICORD

BACK ROW L - R

SWARTZ, ENDERS, BLISS, LOWTHIAN, SLAGTER
MATHIAS, BENKO

HEADQUARTERS SECTION



CHARLES H. MOODY S/SGT
TENNESSEE NASHVILLE
2405 PIERCE AVE
9 JANUARY 1941
CERTIFICATE OF MERIT

S/SGT COLEMAN PERRY
TENNESSEE
BRADYVILLE
17 JANUARY 1941



HENRY D. ROBINSON 1ST SGT
SOUTH CAROLINA COLUMBIA
1609 RUTLAND ST
BRONZE STAR

SGT ALLEN H. BEAL
NASHVILLE TENNESSEE
1809 LILLIAN ST
CERTIFICATE OF MERIT 9 JANUARY 1941



GORDON R. MCCARTHY TEC 4
MAINE HOULTON
21 RELLERAN ST
5 MAY 1943

TEC 4 ELMER C. RANDALL
NORTH CAROLINA
GROVER
CERTIFICATE OF MERIT 14 JANUARY 1941





SAMUEL J. GREER CPL
NORTH CAROLINA
VILAR
21 JANUARY 1941

CERTIFICATE OF MERIT



CPL DONALD M. MATHIAS
MONTE VISTA COLORADO
205 FRANKLIN ST
30 SEPTEMBER 1942

CERTIFICATE OF MERIT



DALE D. UDE TEC 4
NEBRASKA OMAHA 4319 LEVENWORTH ST
30 SEPTEMBER 1942
CERTIFICATE OF MERIT

TEC 5 STANLEY K. BLISS
WINTHROP MASSACHUSETTS
5 PEARL AVE
27 NOVEMBER 1942



JOHN L. HOGAN TEC 5
WISCONSIN KENOSHA
6034 22ND AVE
27 OCTOBER 1942

TEC 5 SIDNEY SLAGTER
CHICAGO ILLINOIS
7026 SOUTH ABERDEEN ST
28 OCTOBER 1942





HARRY L. SWARTZ PFC
PENNSYLVANIA SPRING GROVE
R.F.D. # 2.
20 MAY 1941

PFC KENNETH M. TONKIN
BIWABIK MINNESOTA
BOX #433
2 MARCH 1941



HAROLD J. ENDERS PFC
(MEDICAL DETACHMENT SPECIAL TROOPS)
WASHINGTON D. C.
4527 LILY PONDS DRIVE N. E.
6 JULY 1943

PFC ALMA CARL JURICAK
MICHIGAN
R.F.D. #1
11 NOVEMBER 1942 CERTIFICATE OF MERIT





ALEXANDER W. BENKO PFC
CALIFORNIA SAN FRANCISCO
319 DIVISADERO ST
10 OCTOBER 1942

PFC PAUL G. EBERWEIN
DAYTON OHIO
142 W. ROE AVE
12 OCTOBER 1942



JAMES C. LOWTHIAN PFC
OHIO CLEVELAND
10827 HATHAWAY AVE
12 NOVEMBER 1942

WILLIAM G. MOORE
FRANKLYN INDIANA
800 N. WALNUT ST
7 JUNE 1941



JOHN ORTIZ PFC
NEW YORK NEW YORK CITY
878 MACY PLACE BRONX 55
1 OCTOBER 1942

PFC MILTON W. PEDDICORD
BALTIMORE MARYLAND
488 BRUNSWICK AV
19 OCTOBER 1942

CERTIFICATE OF MERIT



ARMAMENT

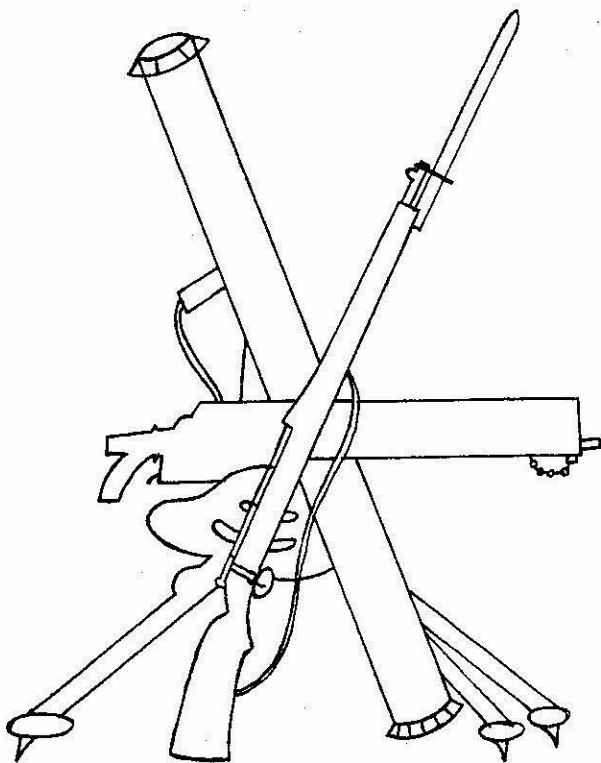



ROBERT B. WAYLAND S/SGT
TENNESSEE KNOXVILLE
R.F.D. #13
17 MARCH 1941

215 No. OAK ST, T/SGT STUART M. HALL
NORTH PLATTE, NEBRASKA
11 AUGUST 1942
BRONZE STAR



JOHN F. MORRIS S/SGT
TENNESSEE TELlico PLAINS
11 JANUARY 1941

142 No. CHURCH ST, TEC 3 CHARLES A. BASIL
BOWLING GREEN, OHIO
11 NOVEMBER 1942
BRONZE STAR



WILLIAM J. TETLOW TEC 3
CONNECTICUT HARTFORD
64 HAZEL ST
14 APRIL 1942 CERTIFICATE OF MERIT

TEC 4 JESSE F. BUCHANAN
SYLVA, NORTH CAROLINA
BOX 75
17 JANUARY 1941





BARNEY CAPEK TEC 4
NEW YORK WOODSIDE, LONG ISLAND
17 APRIL 1941 2448 58th LANE
CERTIFICATE OF MERIT



TEC 4 JACK I. CRAWSHAW
LOS ANGELES, CALIFORNIA
 2354 W. PICO BLVD.
 30 SEPTEMBER 1942



WALTER P. GARRETT TEC 4
TENNESSEE MEMPHIS
40 W McKELLAR
21 JANUARY 1941 CERTIFICATE OF MERIT



TEC 4 ROBERT R. KOKER
 RACINE, ILLINOIS
 4200 - 16TH ST
 29 OCTOBER 1941

ASA S. SCHELL TEC 4
GEORGIA ATLANTA
1606 JAMESBORO ROAD
11 SEPTEMBER 1940

TEC 5 WILLIAM A. BROSIUS
 MINNESOTA
 STILLWATER
CERTIFICATE OF MERIT 10 FEBRUARY 1941





CARL P. FINK TEC 5
OHIO CLEVELAND
14901 DARWIN AVE
5 NOVEMBER 1942

TEC 5 WILLIAM M. McFADDEN
BALTIMORE, MARYLAND
138 S. HIGHLAND AVE
7 OCTOBER 1942



MICHEAL J. NOONAN TEC 5
NEW YORK AUBURN
50 LANSING ST
AUGUST 1942

TEC 5 WILLIAM L. WONNEMAN
BALTIMORE, MARYLAND
3126 GREENMOUNT AVE
30 SEPTEMBER 1942



JOSEPH C. ZANIBONI TEC 5
MASSACHUSETTS WAYLAND
OLD CONNECTICUT PATH
1 SEPTEMBER 1942

TEC 5 EMANUEL A. KNEFEL
ST. LOUIS, MISSOURI
2126a BENTON ST
CERTIFICATE OF MERIT 24 MAY 1943





FRONT ROW, SITTING L - R
HARPER C.W.O. ABLE CAMPBELL.
SECOND ROW, KNEELING, L - R
CLARK, SPARKS, KLAYNER, JONES, KENNEY, MILLER.
THIRD ROW, KNEELING, L - R
DOWNS, ROBINSON, SUAREZ, WEDDINGTON, DAVIDSON.
FOURTH ROW, STANDING L - R
SMITH, STRANZLE, KOHUT, ROWE, TOOLE, SANDERS,
McCARTHY, MAGNACCA.
BACK ROW, STANDING L - R
MARKHAM, BOCK, SHERNOCK, BAHMILLER, YANCEY.

SUPPLY SECTION



HOYTE P. CAMPBELL T/SGT
 TENNESSEE ESTILL SPRINGS
 R.F.D. #2.
 16 SEPTEMBER 1940 CERTIFICATE OF MERIT



S/SGT THOMAS L. CLARK
 Mt. JULIET, TENNESSEE
 R.F.D. # 2
 CERTIFICATE OF MERIT 9 JANUARY 1941



EVERETT O. SPARKS TEC 3
 INDIANA
 PITTSBORO
 1 DECEMBER 1941



SGT EVERETT L. ROWE
 ALBANY CALIFORNIA
 945 VENTURA AVE
 14 NOVEMBER 1941



GEORGE A. YANCEY SGT
 TENNESSEE NASHVILLE
 1305 EDGEWOOD PLACE
 11 FEBRUARY 1940 CERTIFICATE OF MERIT

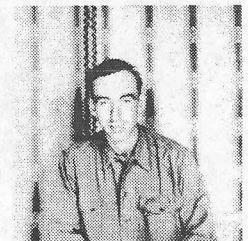

TEC 4 WILLIAM C. WEDDINGTON
 TULLAHOMA, TENNESSEE
 PO BOX #214
 CERTIFICATE OF MERIT 10 JANUARY 1941



GEORGE J. BOCK TEC 5
NEBRASKA LINCOLN 11 NOVEMBER 1942
508 S. 12TH ST
BRONZE STAR



TEC 5 HENRY S. JONES
CAIRO GEORGIA
R.F.D. #2
CERTIFICATE OF MERIT 23 SEPTEMBER 1939



ANTHONY J. KLAYNER TEC 5
PENNSYLVANIA PITTSBURGH
256 38TH ST
12 OCTOBER 1942



TEC 5 GILBERT J. KOHUT
AKRON OHIO
899 WOODWARD AVE
1 OCTOBER 1942



ALFRED D. MAGNACCA TEC 5
NEW YORK NEW YORK
1254 62ND ST, BROOKLYN
14 OCTOBER 1942



RUDOLF C. MILLER
NEVADA
FERNLEY
17 FEBRUARY 1942



HARRY L. SANDERS TEC 5
CALIFORNIA SANTA BARBARA
1226 ANACAPA ST
12 OCTOBER 1942 CERTIFICATE OF MERIT



TEC 5 JAMES SUAREZ
BALTIMORE MARYLAND
3010 FRISBY STREET
CERTIFICATE OF MERIT 30 SEPTEMBER 1942



OTTO W. BAHMILLER PFC
OHIO CANTON
207 KENNETT COURT N W
10 NOVEMBER 1942



PFC AMOS M. DAVIDSON
 TENNESSEE
 DAISY
12 SEPTEMBER 1942



WILLIAM L. DOWNS PFC
GEORGIA MITCHELL
R.F.D. # 1
16 JANUARY 1941



PFC DANIEL F. KENNEY
BOSTON MASSACHUSETTS
46 VERNON STREET
7 SEPTEMBER 1942



IRVING SHERNOCK PFC
NEW YORK NEW YORK
1695 MADISON AVE
15 MARCH 1943



PFC STEPHEN STRANZLE
NEW YORK NEW YORK
320 EAST 70 ST
1 JANUARY 1942

CECIL O. MARKHAM TEC 3
MISSOURI KANSAS CITY
2819 CAMPBELL STREET
BRONZE STAR 24 FEBRUARY 1942



T/SGT JOHN B. HARPER
SECTION LEADER SUPPLY
NASHVILLE TENNESSEE
D-3 AMBASSADOR APTS
16 SEPTEMBER 1940



JOHN B. TOOLE TEC 5
NEW YORK FORT EDWARD
48 MECHANIC STREET
2 OCTOBER 1942

AUTOMOTIVE

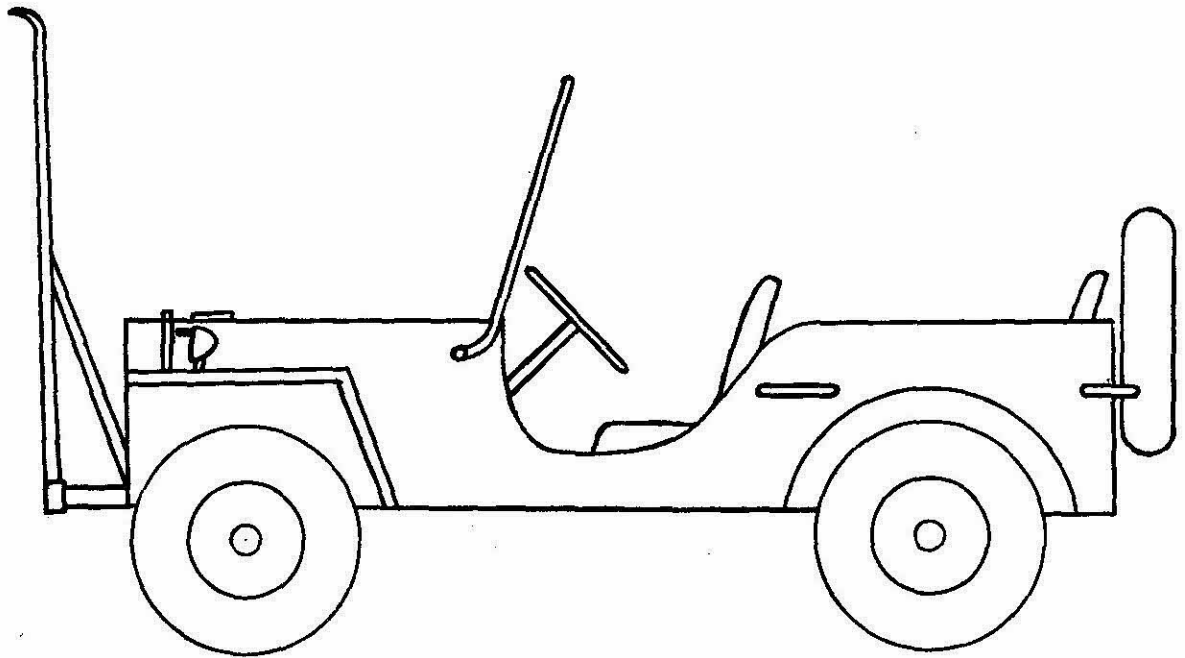

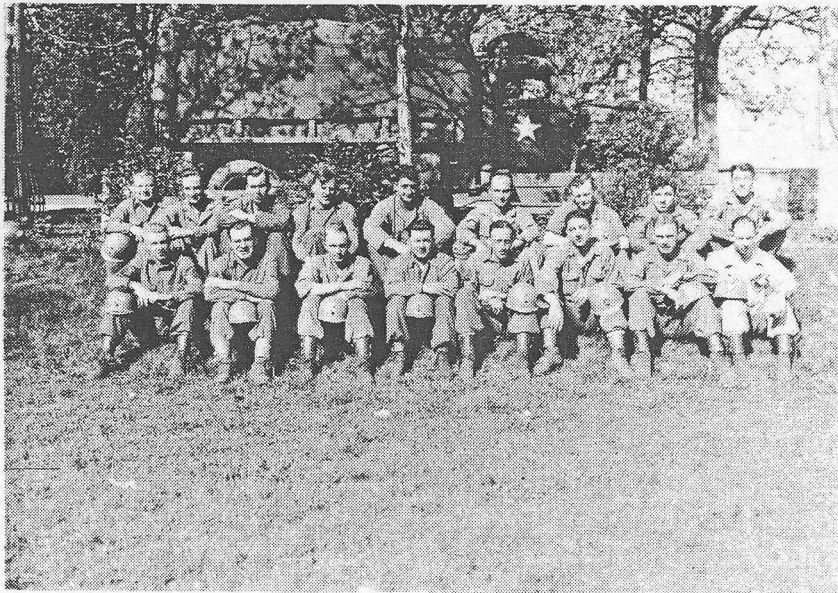

FRONT ROW L - R

REESE, PELLICIONI, SMOAK, NOVAK, SMITH, BROWN, WEAVER
MOORE

BACK ROW L-- R

SELDERS, HUGUET, HILL, LIDSTONE, POOLE, BLACK, ARMSTRONG
VECCHIO, HECKLE

ENGINE BAY

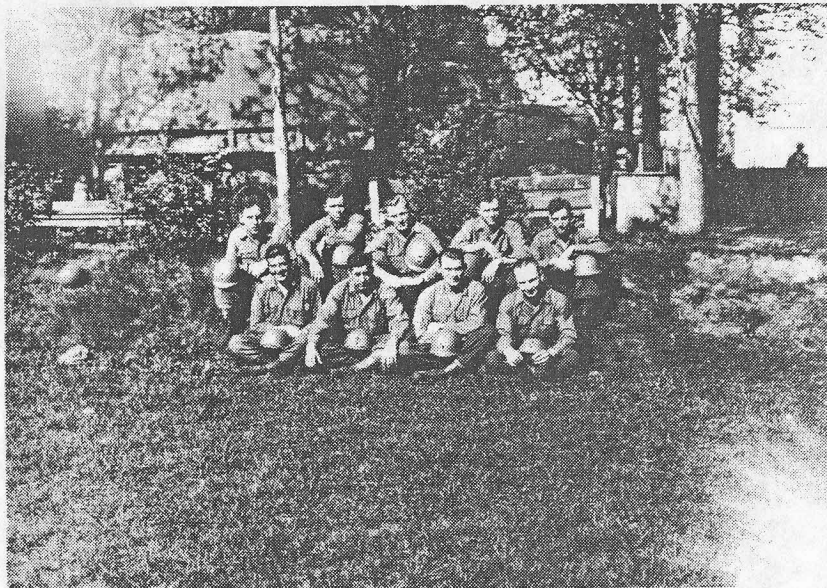

FRONT ROW L - R

PRINZO, LASSAK, VILLAR, BRUCE

BACK ROW L - R

HOLLOMAN, BOLDEN, JOHNSON, COKER, LOWIN

EVACUATION AND RECOVERY SECTION

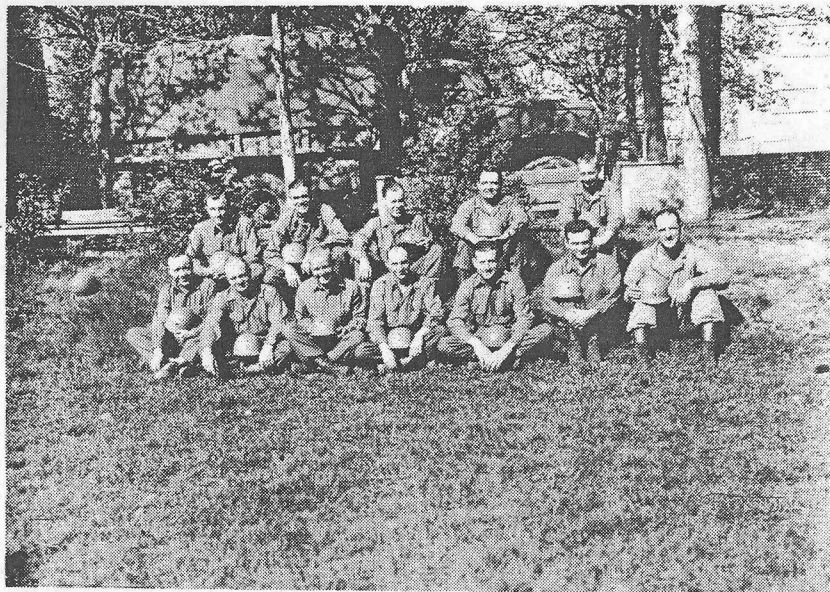

FRONT ROW L - R

MOSS, HOOPER, HOLTZ, CARNEY, DECK, GARLAND, ROBINETTE

BACK ROW L - R

HULS, HOWARD, THOMAS, STRIPLING, POWELL

HEAVY UNITS BAY

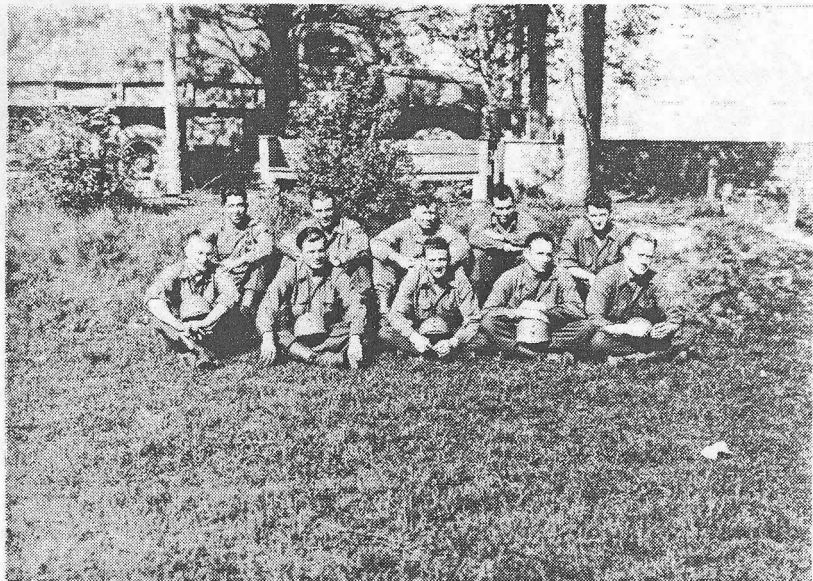

FRONT ROW L - R

SALISBURY, MOZE, INGRAM, MILAN, HARRIS

BACK ROW R - L

MONTOYA, FREEZE, FULGHUM, HELLAMS, HEIDRICH

WELDING BAY



RICHARD R. LIDSTONE TEC 3
MAINE WINTHROP
8 NOVEMBER 1942
CERTIFICATE OF MERIT

TEC 3 MONROE C. MILAN
NASHVILLE TENNESSEE
9 JANUARY 1941
CERTIFICATE OF MERIT



ROY B. REESE TEC 3
TENNESSEE JEFFERSON CITY
R.F.D. #2
16 JANUARY 1941

TEC 3 HERMAN ROBINETTE
ROGERSVILLE TENNESSEE
16 JANUARY 1941
BRONZE STAR



MARVIN C. STRIPLING TEC 3
GEORGIA CARLELE R.F.D. #A
22 JANUARY 1941
CERTIFICATE OF MERIT

TEC 3 JOHN A. VILLAR
NEW YORK CITY NEW YORK
542 EAST 87TH ST
12 JUNE 1941 BRONZE STAR





RAY J. MARTIN S/SGT
TENNESSEE NASHVILLE
5106 ALABAMA AVE
16 SEPTEMBER 1940



S/SGT MARVIN POOLE
SPRINGFIELD TENNESSEE
16 SEPTEMBER 1940
BRONZE STAR



ERBIE S. FULGHUM TEC 3
TENNESSEE DONELSON
9 JANUARY 1941
CERTIFICATE OF MERIT



TEC 3 JOHN C. HARRIS
R.F.D. #1 MANCHESTER TENNESSEE
17 SEPTEMBER 1940
CERTIFICATE OF MERIT BRONZE STAR



WILLIAM B. HECKLE TEC 3
SOUTH CAROLINA
SAINT MATTHEWS
22 JANUARY 1941 CERTIFICATE OF MERIT



TEC 3 FLOYD E. INGRAM
NASHVILLE TENNESSEE
1207 FORREST AVE
16 SEPTEMBER 1940



CHESTER W. PELLICCIONI TEC 4
PENNSYLVANIA GALLITZIN
178 FOREST ST
CERTIFICATE OF MERIT 6 JUNE 1941

TEC 4 RUBEN L. SMITH
ESTILL SPRINGS TENNESSEE
16 SEPTEMBER 1940
CERTIFICATE OF MERIT



DAN A. SMOAK TEC 4
SOUTH CAROLINA CORDOVA
21 JANUARY 1941
CERTIFICATE OF MERIT

TEC 4 RONALD W. THOMAS
COLUMBIA SOUTH CAROLINA
22 JANUARY 1941
CERTIFICATE OF MERIT



DONALD R. BAKER TEC 5
PENNSYLVANIA
MEADVILLE
6 NOVEMBER 1941

TEC 5 LESTER K. BROWN
PENNSYLVANIA
ORANGEVILLE
3 SEPTEMBER 1942





FRED L. WEAVER TEC 3
SOUTH CAROLINA JOHNSVILLE
22 JANUARY 1941
CERTIFICATE OF MERIT

SGT ODIE W. BROWN
 TENNESSEE
 DICKSON



WALTER G. LASSAK SGT
PENNSYLVANIA CRESSON BOX 113
6 JUNE 1941
CERTIFICATE OF MERIT

TEC 4 JOHN L. ARMSTRONG
 FLINTVILLE TENNESSEE
 BOX #27
 17 JANUARY 1941



WOODROW W. BLACK TEC 4
SOUTH CAROLINA GAFFNEY
13 JANUARY 1941
CERTIFICATE OF MERIT

TEC 4 JAMES R. FREEZE
 MORRISON TENNESSEE
 BOX #162
 18 JANUARY 1941





EDWARD G. HEIDRICH TEC 4
CALIFORNIA LOS ANGELES
8616 1/2 HICKORY STREET
CERTIFICATE OF MERIT 14 NOVEMBER 1942



TEC 4 ROBERT V. HELLAMS
CENTRAL SOUTH CAROLINA
15 JANUARY 1941
CERTIFICATE OF MERIT



JOHN A. HILL TEC 4
SOUTH CAROLINA WARE SHOALS
17 JANUARY 1941
CERTIFICATE OF MERIT



TEC 4 HOWARD G. HOOPER
NASHVILLE TENNESSEE
525 FATHERLAND STREET
CERTIFICATE OF MERIT



ALOYSIUS J. HULLS TEC 4
SOUTH DAKOTA, SALEM
25 FEBRUARY 1942



TEC 4 JACOB LEONHARDT
GROING NEBRASKA
1920 5TH STREET
29 APRIL 1942 CERTIFICATE OF MERIT



DOUGLAS W. HOWARD TEC 5
WASHINGTON D. C.
205 9TH STREET S.E.
16 SEPTEMBER 1940

TEC 5 CLEMENS L. HUGUET
INDIANA
FRANCESVILLE
21 MAY 1941



ERICK C. JOHNSON TEC 5
ILLINOIS CHICAGO
4850 WEST AGUSTA BLVD
CERTIFICATE OF MERIT 11 NOVEMBER 1942

TEC 5 JAMES LOWIN
HARRISON NEW JERSEY
749 HAMILTON STREET
CERTIFICATE OF MERIT
21 OCTOBER 1942



JOSEPH MONTOYA TEC 5
NEW MEXICO SANTA CRUZ
10 JANUARY 1943
CERTIFICATE OF MERIT

TEC 5 FRANK G. MOSS
CEDAR HILL TENNESSEE
R.F.D. #1
21 SEPTEMBER 1942





VERNON H. BRUCE TEC 5
INDIANA CORUNNA
R.F.D. #1
10 JUNE 1942 CERTIFICATE OF MERIT

TEC 5 ROY L. CARNEY
 TENNESSEE
 ASHVILLE CITY
 5 AUGUST 1942



RALPH D. COKER TEC 5
GEORGIA ATLANTA
133 10th STREET
CERTIFICATE OF MERIT 28 OCTOBER 1942

TEC 5 JAMES E. DECK
OLD HICKORY TENNESSEE
 112 28TH STREET
 9 JANUARY 1941



LEONARD H. GARLAND TEC 5
TENNESSEE SOUTH PITTSBURG
17 JANUARY 1941
CERTIFICATE OF MERIT

TEC 5 JAMES W. HOLTZ
INDUSTRIAL WEST VIRGINIA
 5 OCTOBER 1942
 CERTIFICATE OF MERIT





JOSEPH MOZE TEC 5
OHIO CLEVELAND
1044 EAST 70TH STREET
8 AUGUST 1941

TEC 5 ANTHONY J. NOVAK
CLEVELAND OHIO
1128 EAST 63RD STREET
16 JUNE 1941



FRANK L. PERKINSON TEC 5
MARYLAND BALTIMORE
2006 BOYD STREET
2 JUNE 1941

TEC 5 JOHN J. POWELL
COLLIDGE GEORGIA
7 SEPTEMBER 1940
CERTIFICATE OF MERIT



MICHEAL F. PRINZO TEC 5
NEW YORK BROOKLYN
520 RUTHLAND ROAD
30 SEPTEMBER 1942

TEC 5 HENRY F. SALISBURY
PENNSYLVANIA
BEECH CREEK
14 OCTOBER 1942





JOSEPH VECCHIO TEC 5
RHODE ISLAND PROVIDENCE
13 ANDEM STREET
CERTIFICATE OF MERIT 9 OCTOBER 1941

PFC LOUIS M. JOE
ASTORIA NEW YORK
3264 41ST St
1 OCTOBER 1942



EARL D. MOORE PFC
TENNESSEE
SHELBYVILLE
17 JANUARY 1941

TEC 4 ROSS T. SELDERS
BLOOMINGTON, ILLINOIS
6 ROSS DRIVE
27 JANUARY 1940



HARVEY C. HOLLOWAN
SOUTH CAROLINA BISHOPVILLE
RFD. #3.
28 APRIL 1941